

1 2 3 4 5 6

A

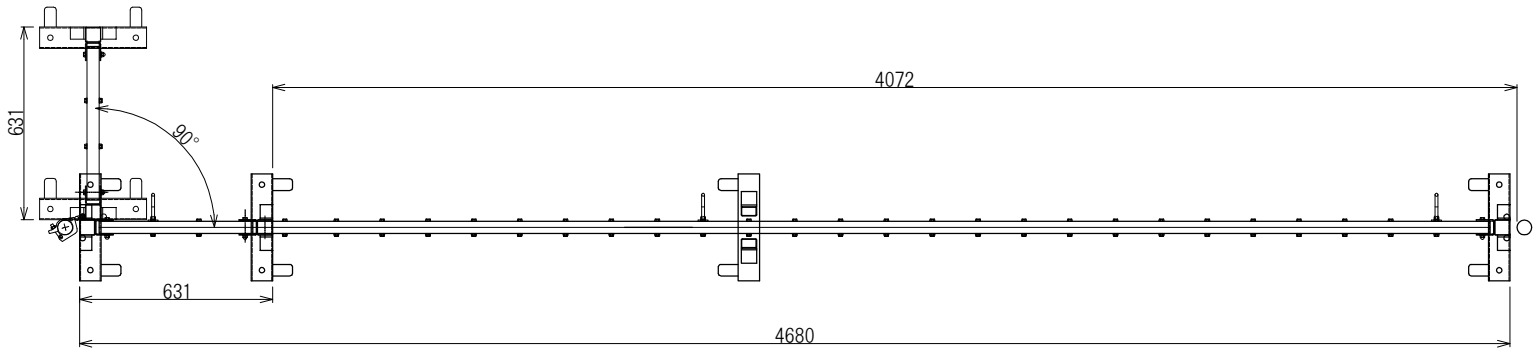

B

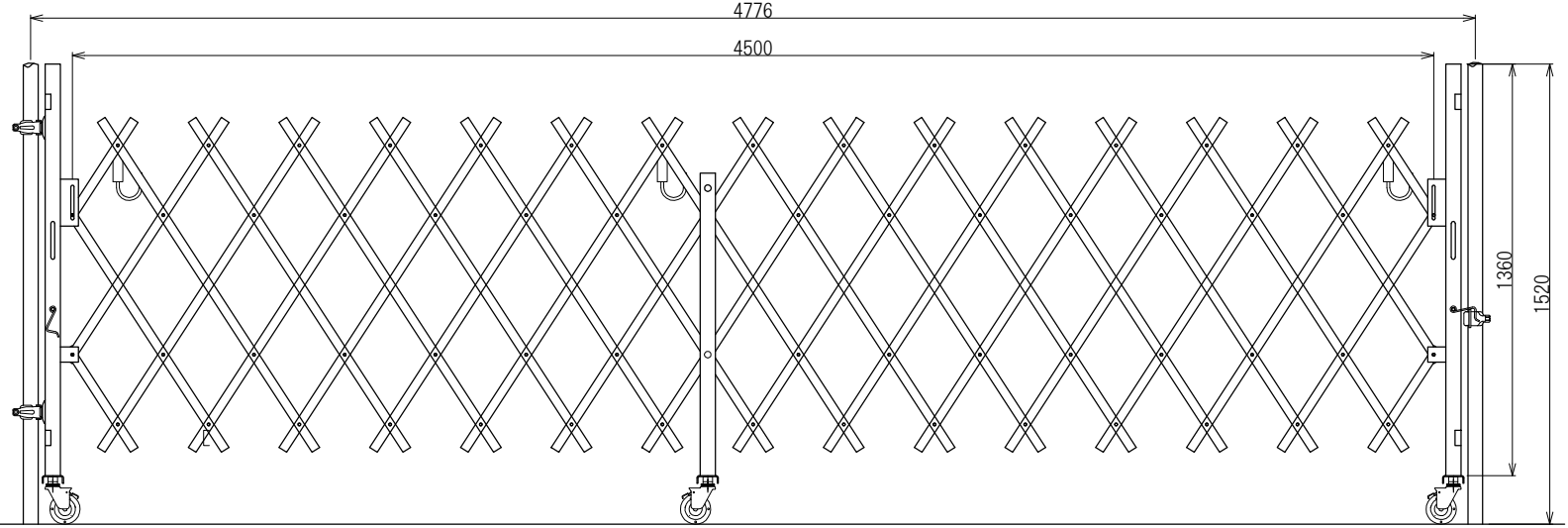
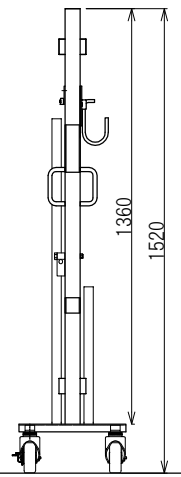
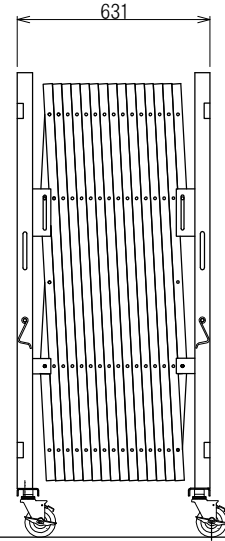

C

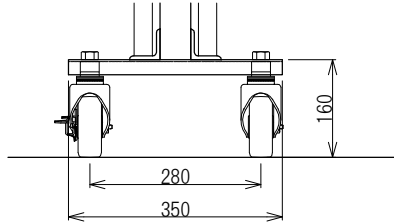
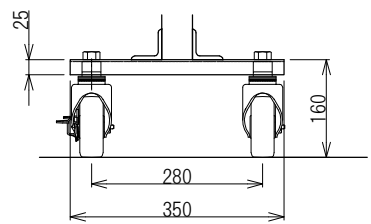
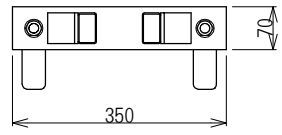
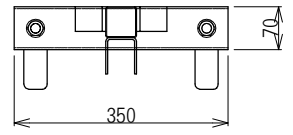

先頭柱 1:2

中間足 1:2

D

<b>日進建機株式会社</b>				型 格	PARTS NO.	材 質	MATERIAL	数 量	QTY
				名 称		アコーディオンゲート ALTB45N			
尺 度	SCALE	1:12	作 成 日	DATE	14.11.14				
承 認	検 査	設 計	製 図						
APPROVED	CHECK	DESIGN	DRAWN						
				図 番	DRAWING NO.				

