

1

2

3

4

A

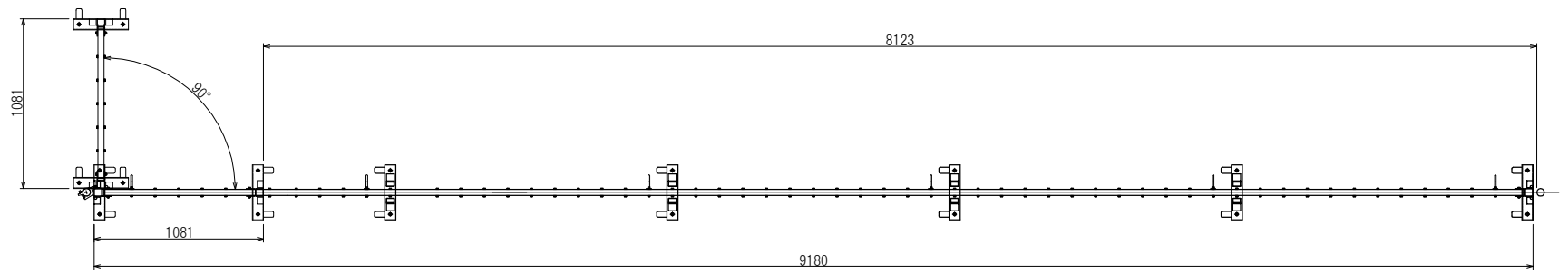

B

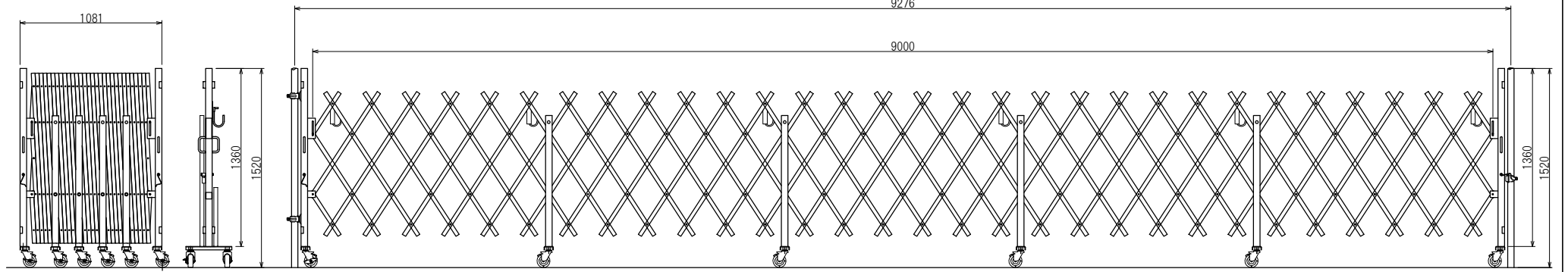

C

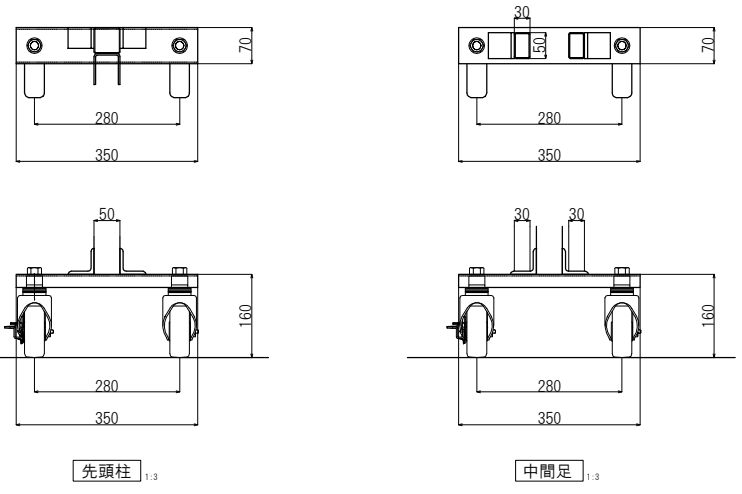

日進建機株式会社				型格	PARTS NO.	材質	MATERIAL	数量	QTY
				名 NAME アコーディオンゲート ALTB90N					
尺度	SCALE	1:30	作成日	DATE	17.01.25				
承認	検図	設計	製図						
APPROVED	CHECK	DESIGN	DRAWN						
				図番	DRAWING NO.				

