

1

2

3

4

A

B

C

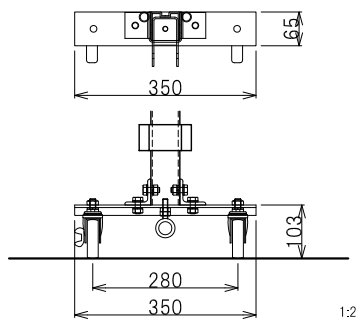
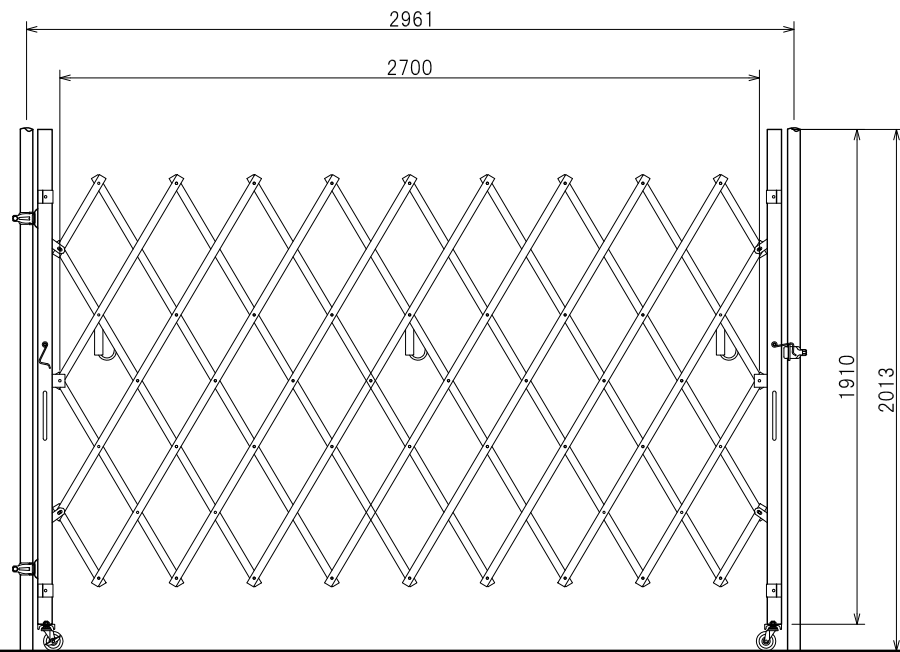
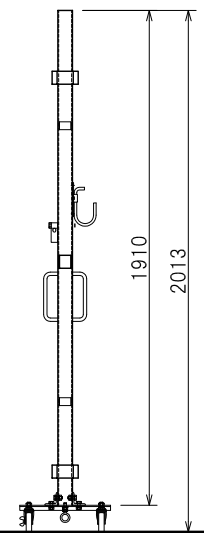
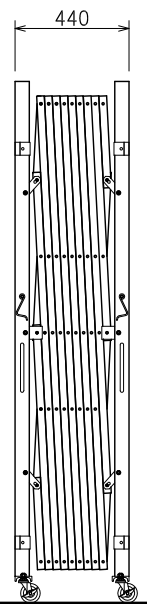
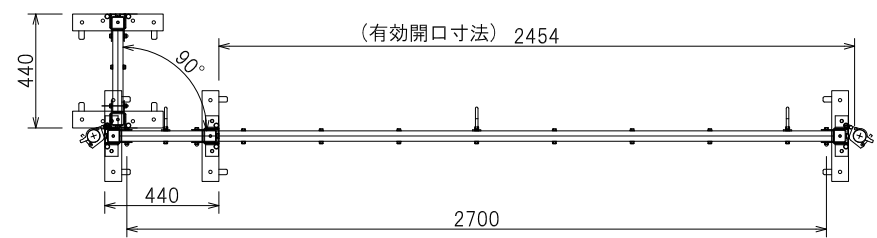

△				
△				
△				
MARK	REVISID RECORD	DATE	PERSON	APPROVED
記号	変更事項	日付	変更者	承認

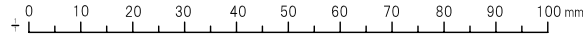
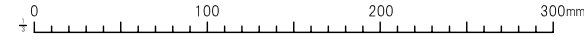

<p align="center"><b>日進建機株式会社</b></p>				型格	PARTS NO.	材質	MATERIAL	数量	QTY
				名	アルミ アコーディオンゲート AAH027N				
承認	検図	設計	製図	称	DRAWING NO.				
APPROVED	CHECK	DESIGN	DRAWN	図番					
尺度 SCALE 1:15 作成日 DATE 17.08.28									